



SPECIAL PURPOSE VEHICLE

側滾輪軸承 SIDE THRUST ROLLER

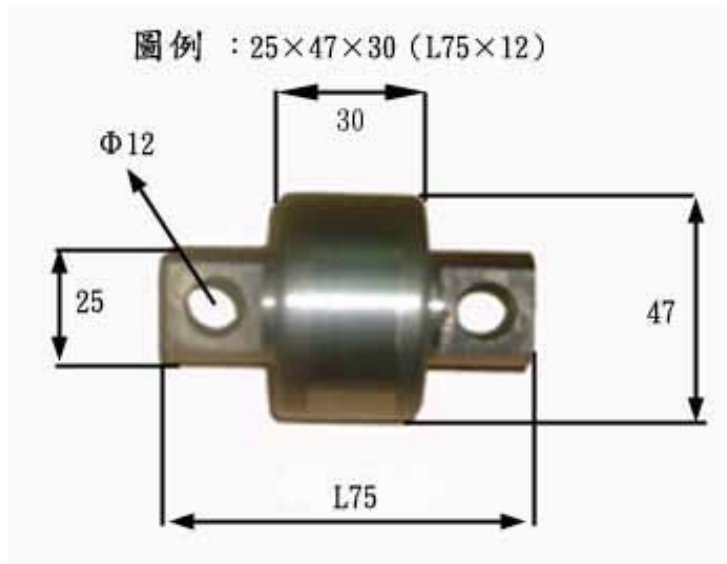

Photo Reference.	Specifications Pin w.x bearing W.x bearing H	Make	Model no.	Remarks
	17x47x22 (L65x11)	TCM	SR-2227 (62036-21402)	心無牙 <u>PCD45</u>
	T18x38x24 升降心無牙	KOMATSU FD30 夾包	SR-2202 (46B-225-1370)	<u>PCD36</u>
	20x41x30 (L70.5x9)	NISSAN FB15	SR-2226-4	心無牙
	20x42x30 (L80x10)	TCM 1.5T	SR-2219-3 (94010-08700)	心有牙 <u>PCD60</u>
	20x42x30 (L80x11)	TCM 3T (雙平)	SR-2245 (23458-32051)	心無牙 <u>PCD60</u>
	20x42x30 (L80x11)	MITSUBISHI 2-3T (半圓)	SR-2245-1 (94010-09700)	心無牙 <u>PCD60</u>



SPECIAL PURPOSE VEHICLE

Photo Reference.	Specifications Pin w.x bearing W.x bearing H	Make	Model no.	Remarks
	20x42x36 (L80x10)	MITSUBISHI S4E	SR-2219 (94211-05700)	心有牙 <u>PCD60</u>
	20x42x36 (L80x10.5) 扁心	MITSUBISHI S4E 1.5T	SR-2219-1 (94010-09601)	心無牙 <u>PCD60</u>
	20x42x36 (L85x10.5)	NISSAN	SR-2254 (59532-L1100)	心無牙 <u>PCD60</u>
	20x58x30 (L80x12.5)		SR-2204 (23458-32051)	心有牙 <u>PCD60</u>
	20x58x30 (L80x12.5)	TCM 3T 700型	SR-2208	心無牙 <u>PCD60</u>
	22x40x30 (L75x11)	NISSAN FB15	SR-2226-1	心無牙 <u>PCD55</u>
	22x40x30 (L80x11)	NISSAN	SR-2226-2 (22018-30304)	心無牙 <u>PCD60</u>
	22x40x30 (L65x11)		SR-2226-3	心無牙 <u>PCD50</u>
	22x45x24 升降心無牙	TOYOTA 3F 心51.6MM	SR-2201 (63382-30800-71)	<u>PCD40</u>
	24x51x30 (L60x8)	TOYOTA 3/5FD30	SR-2232 (84634-38200-71)	心無牙 <u>PCD45</u>
	24.5x47x30 (L75x10)	NYK 1.5/2.5T	SR-2206 (31220-11350)	心有牙 <u>PCD55</u>



SPECIAL PURPOSE VEHICLE

Photo Reference.	Specifications Pin w.x bearing W.x bearing H	Make	Model no.	Remarks
	24.5x47x30(L75x11)		SR-2207-1 (70000-16250)	心無牙
	25x40x50 (L84x5)	NISSAN (ELECTRICITY TYPE)	SR-2257	心無牙
	25x47x30(L75x12)	NISSAN 2.5T	SR-2207 (59532-L2901)	心無牙 <u>PCD55</u>
	25X47X30(L80x13)	YALE 2T	SR-2205 (234A8-33401)	心無牙 <u>PCD60</u>
	25X52X25 (L63x9)	YANG 2.5T	SR-2243	心無牙 <u>PCD45</u>
	25x52x30 (L60x8.5)	YALE 2.5T	SR-2260	心無牙 <u>PCD46</u>
	25x52x30 (L84x10)	MITSUBISHI 4T	SR-2219-2 (94401-03700)	心有牙 <u>PCD60</u>
	25x52x36(L85x10)	MITSUBISHI 4T	SR-2214 (94401-03500)	心有牙 <u>PCD60</u>
	25x54x30(L80x12) 扁心-12MM	TCM 2.5T T6	SR-2239	心無牙 <u>PCD60</u>
	25x54x30(L80x12) 扁心-16MM	TCM 2.5T T6	SR-2239-1	心無牙 <u>PCD60</u>
	25x58x30(L80x12)	TCM 2.5T	SR-2211 (23458-32052)	心無牙 <u>PCD60</u>













SPECIAL PURPOSE VEHICLE

Photo Reference.	Specifications Pin w.x bearing W.x bearing H	Make	Model no.	Remarks
	25x58.5x22 (L74x12.5)	TOYOTA 7FD20	SR-2238 (61451-13000-71)	心無牙 <u>PCD52</u>
	25x62x18 (L74x13) 扁心	TOYOTA 6FD25 側移,牙排	SR-2215	心無牙 <u>PCD52</u>
	25x62x20 (L74x13)	TOYOTA 5F 貨櫃拱	SR-2216	心無牙 <u>PCD52</u>
	25x62x20 (L70x13)		SR-2216-1	心有牙
	25x62x24 (L68x13)	TOYOTA 5FD25	SR-2229	心無牙 <u>PCD52</u>
	25x65x22 (L74x13)	TOYOTA 6/7FD15/25牙排	SR-2217	心無牙 <u>PCD52</u>
	25x65x25 (L70x10)		SR-2236	心有牙 <u>PCD50</u>
	25x65x25 (L70x11)	TAILIFT 2.5T	SR-2237-1	心無牙 <u>PCD52</u>
	25x65x25 (L74x13)		SR-2237	心無牙 <u>PCD52</u>
	25x67x26 (L70x11)	KOMATSU 11S	SR-2210	心無牙 <u>PCD52</u>
	25x67x32.5 (L85x12.6)	TCM 4T TOYOTA 5FD30	SR-2212 (23818-30301)	心無牙 <u>PCD65</u>













SPECIAL PURPOSE VEHICLE

Photo Reference.	Specifications Pin w.x bearing W.x bearing H	Make	Model no.	Remarks
	25x67x33 (L85x11)	TCM 4T	SR-2231 (23818-20302)	心有牙 <u>PCD65</u>
	25x68x26 (L70x10)	TCM 2.5T	SR-2222	心無牙 <u>PCD50</u>
	25x70.5x22 (L74x12.5)	TOYOTA 7FD25	SR-2253	心無牙 <u>PCD52</u>
	25x72x28/28 (L85x10.5)	TOYOTA 8FD25	SR-2263	心無牙 <u>PCD62</u>
	25x74x25 (L70x10) 半圓厚-18MM	TAILIFT 2.5T	SR-2223	心有牙 <u>PCD50</u>
	25x74x25 (L70x10) 半圓厚-15MM	TOYOTA 7FD25	SR-2223-1	心有牙 <u>PCD50</u>
	25x80x22 (L70x13)	TCM 2.5T	SR-2218	心無牙 <u>PCD50</u>
	25x80x23 (L70x13)	TCM 2.5T D700	SR-2213	心無牙 <u>PCD50</u>
	25x80x23 (L70x13)	TCM 2.5T Z-2	SR-2221	心有牙 <u>PCD50</u>
	25x80x23 (L72x13)	TOYOTA 5FD25/40	SR-2225	心無牙 <u>PCD52</u>
	25x80x23.6 (L74x10.5)	TOYOTA 8FD25	SR-2233-2 (63375-26600-71)	



SPECIAL PURPOSE VEHICLE

Photo Reference.	Specifications Pin w.x bearing W.x bearing H	Make	Model no.	Remarks
	25x80x23.6 (L74x13) 扁心-9MM	TOYOTA 牙排 6FD30/7FD25	SR-2233	心無牙 <u>PCD52</u>
	25x80x25 (L70x10)	YANG 3.5T	SR-2248	心有牙 <u>PCD50</u>
	27.5x52x30 (L96x13)	SUMITOMO 4T	SR-2220-1 (9094823-00)	心無牙 <u>PCD74</u>
	30x83x36 (L90x13)	TCM 6-10T	SR-2234 (22658-32941)	心無牙 <u>PCD70</u>
	30x96x65 (L160x12) 一邊有孔 12MM, 一邊鎖牙	TCM 10-13T	SR-2230	心無牙
	31x58x40 (L88x11)	MITSUBISHI 7T	SR-2235 (94511-10400)	心無牙 <u>PCD64</u>
	34x67x26(L70x10)	KOMATSU 12S/15S/16S	SR-2209 (3EB-71-33260)	心無牙 <u>PCD50</u>
	35x94x28 (L93x14) 扁心-14MM	TOYOTA 5/6FD35/40	SR-2250	心無牙 <u>PCD64</u>
	35x102x65 (L160x12)	TCM 13T	SR-2249	心無牙
	40x100x30 (L90x10)	TOYOTA 7FD40/45	SR-2241 (76181-30340-71)	心有牙 <u>PCD60</u>
	40x100x30 (L97x14.5)		SR-2241-1	心無牙



SPECIAL PURPOSE VEHICLE

Photo Reference.	Specifications Pin w.x bearing W.x bearing H	Make	Model no.	Remarks
	42x80x30 (L90xM10x <u>1.25</u>)	KOMATSU 4T 7S	SR-2246	<u>PCD60</u>
	42x80x30 (L90xM10x <u>1.5</u>)		SR-2246-1 (3EC-71-33910)	<u>PCD60</u>
	45x(95+12)x75(L162x12) 附油封 45x55x4 (x2pcs)	TCM 15-20T 5型	SR-2259	心無牙
	45x96x75 (L160x12) 一邊有孔 12MM,一邊鎖牙	TCM 15-20T 4型	SR-2244	心無牙
	45x123x75 (L189x12)	TCM 25T	SR-2251	心無牙
 40m/m	50x98x82 (L157x12) 附墊片 With washer	TCM 24T/28T	SR-2261	心無牙





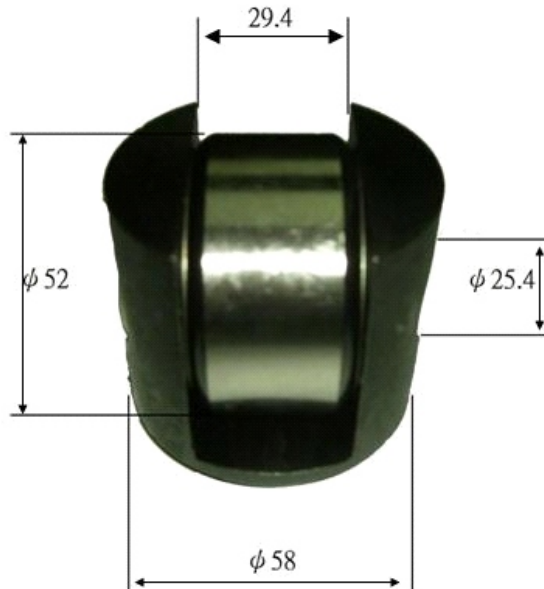

SPECIAL PURPOSE VEHICLE

連座軸承 Connecting Seat Bearing

Photo Example : Dia of Pin Hole -25.4 × 52 H. × 29.4 W. × 58 bottom)
connecting seat



	16x33x22.4x42	TOYOTA FD30	SR-2228	
	16x35x24x40	YALE	SR-2224 (31220-05540)	
	BOLT -ADJUSTMENT	NICHIYU FBR14-18 60S-85S	SR-2224-B (14601-17550)	
	19x39x30x42.5	TCM FD25	SR-2203 (62036-22512)	
	22x40x26.4x47	TCM NISSAN	SR-2252	
	22x40x26.4x47x44H	NISSAN (有2小油孔)	SR-2252-1	
	25x52x35x66	TCM	SR-2255	

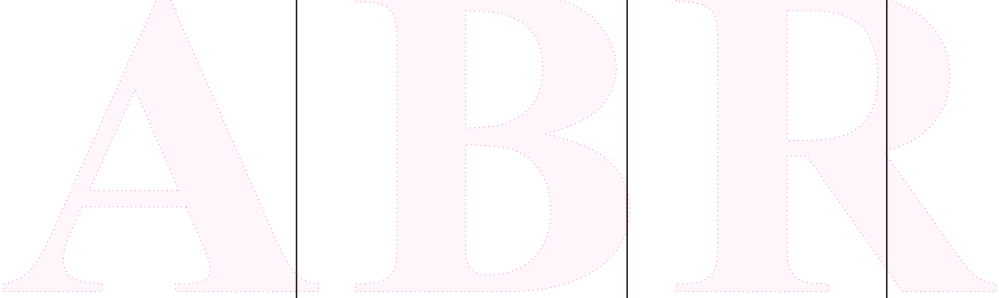

SPECIAL PURPOSE VEHICLE

		TCM FD60 Z-7 側導輪座	SR-2262
	30x32x24	TCM FD25/40 側導輪座	SR-2265 附墊片
			



SPECIAL PURPOSE VEHICLE

HYDRAULIC PUMP 油壓邦浦 (KAYABA)

OEM NO against Model no of KAYABA Hydraulic Pump

OEM NO. 1	KYB MODEL NO. 1	Remark	OEM NO. 2	KYB MODEL NO. 2	Remark
99371-00300	KRP4-33AEND		67110-22020-71	KRP4-23CSSFD	
	KRP4-33AMJ		13077-10201(A)	KRP4-23CSSBQ	
16442-52021	KRP4-33ASBS		69101-L1403	KRP4-23CV	
91471-36100	KRP4-33AVHH		69101-L1100	KRP4-23CV	
37B-1KB-2030	KRP4-33ASSB		69101-L1404	KRP4-27CV	
78142-33215	KRP4-33ASSB		69101-L1407	KRP4-27CV	
37B-1KB-2031	KRP4-33ASSBDD		69101-L1102	KRP4-27CV	
54452-10401A	KRP4-33ASSBQ		69101-11H01	KRP4-27CVMF	
91471-36100	KRP4-33AVHH		91571-00100	KRP4-30AEND(J)	
L91-60-11510	KRP4-33CSSB		37B-1KB-2020	KRP4-30ASSB	
3EB-60-11510	KRP4-33CSSBDD		37B-1KB-2021	KRP4-30ASSBDD	
15847-10201(A)	KRP4-33CSSBQ		13657-10201(A)	KRP4-30ASSBQ	
15847-39564	KRP4-33CSSBQ		91271-36200	KRP4-30AVHH	
67110-00118-71	KZP4-23CSMFDD		B5910-19009	KRP4-33ASBS	
67110-13600-71	KZP4-23CSMFDD		67110-22020-71	KRP4-23CSSFDN	
67110-22071-71	KZP4-23CSSDD		69101-51K01	KFP22-27CSMSJ	
3BC-60-11110	KZP4-27A		69101-11H00	KRP4-23CVMFJ	
3EB-60-12510	KZP4-27ASSB		691019-11H01	KRP4-27CVMFJ	
3EB-60-12411	KZP4-27ASSDD		FF200D	KFZ4-25CSKS	
69101-41H00	KZP4-27CSBBF		FF201E	KFZ4-27CSKS	
67110-23640-71	KZP4-27CSMF		FF202F	KFZ4-28.3CSKS	
67110-00268-71	KZP4-27CSMFDD				
67110-32071-71	KZP4-27CSSDN				
67110-32070-71	KZP4-27CSSFDZ				
67110-23021-71	KZP4-27-KRP4-5C				
67110-23860-71	KZP4-28-KRP4-5CF				
67120-03820-71	KZP4-28-KRP4-5CF				
67110-23861-71	KZP4-28-KRP4-5CFDD				
67110-23871-71	KZP4-28CSSDD				
91471-26100	KZP4-33AVH				
126A-10271	DGP22-27CSBEX				
67110-12191-71	DGP4-16C				
H26-1KA-3020	KFP22-23CSMS				
	KFP22-27CSKSJ				
69101-51K01	KFP22-27CSMSN				
133A-10201	KFP22-28CSBS				
114A7-11301	KFP22-30ASBS				
129F1-10301	KFP22-30CSBS				
69101-51K02	KFP22-30CSMSN				
117M7-10321	KFP22-32ASBS				
91771-00100	KFP32-40AMBAS				
91871-32100	KFP32-50AMBSSL				
69101-51H01	KFP32-50ASMSS				
26437-12012B	KFP51-71CSMSF				
3EB-60-11110	KRP4-19CSSB				
3EB-60-11210	KRP4-23CSSB				
37B-1KA-204X	KRP4-23CSSBK				
3ED-60-12251	KRP4-23CSSBKD				



SPECIAL PURPOSE VEHICLE

MEMO

ABR



SPECIAL PURPOSE VEHICLE

MEMO

ABR